

Peak Emission Wavelength: 365nm

The MT3660 C5-UV is a ultraviolet 3mm water clear LED designed for applications requiring high brightness and high reliability.

FEATURES

- > High Brightness
- > High Reliability
- > Water Clear with Flange
- > Narrow Beam Angle

APPLICATIONS

- > Currency Validation
- > Driver License & Passport Identification
- > Medical & Analytical Instruments
- > Fluorescence



Absolute Maximum Ratings (Ta=25°C)



ITEMS	SYMBOL	RATINGS	UNIT
Forward Current	IF	25	mA
Forward Current (Pulse)*1	IFP	80	mA
Reverse Voltage	VR	5	V
Power Dissipation	PD	100	mW
Operating Temperature Range	Topr	-20 ~ +80	°C
Storage Temperature Range	Tstg	-30 ~ +100	°C
Lead Soldering Temperature*2	Tls	260	°C

*1: Tw=10uS, T=10mS *2: Time 5 Sec max, Position: Up to 3mm from the body.

Electrical & Optical Characteristics (Ta = 25°C)

ITEMS	SYMBOL	CONDITIONS	MIN	TYP	MAX	UNIT
Forward Voltage	VF	IF=20mA	--	3.4	--	V
Power Output	PO	IR=20mA	--	7.3	--	mW
Reverse Current	IR	VR=5V	--	--	100	uA
Peak Emission Wavelength	λ_p	IF=20mA	--	369	--	nm
Spectral Bandwidth at 50%	$\Delta\lambda_{0.5}$	IF=20mA	--	17	--	nm
Viewing Angle	Θ	IF=20mA	--	+/-11	--	deg.

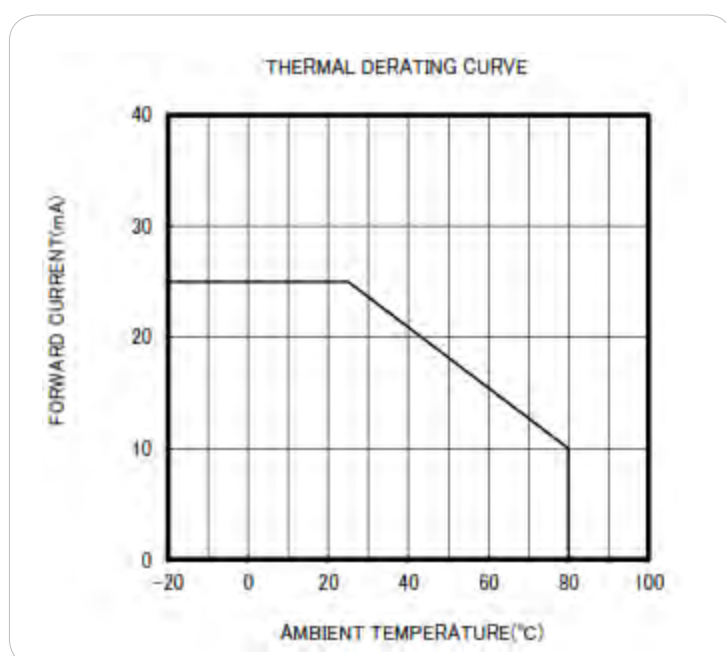
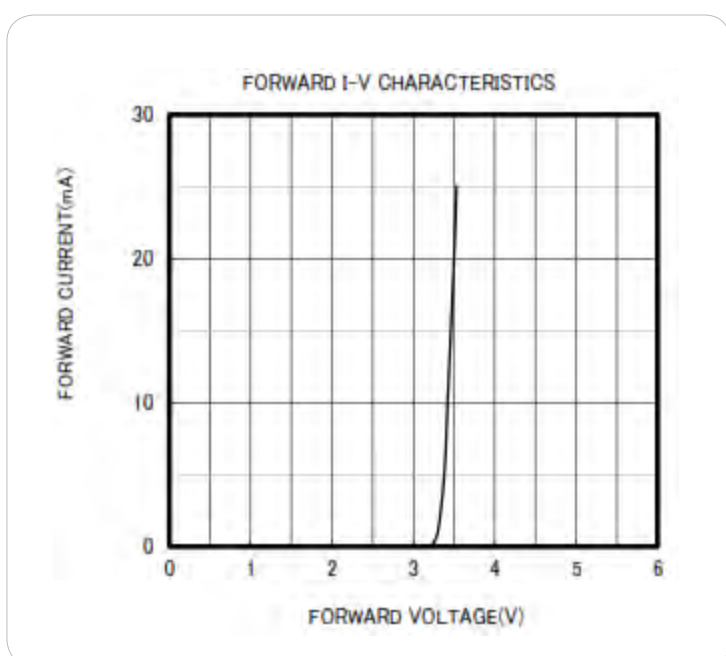
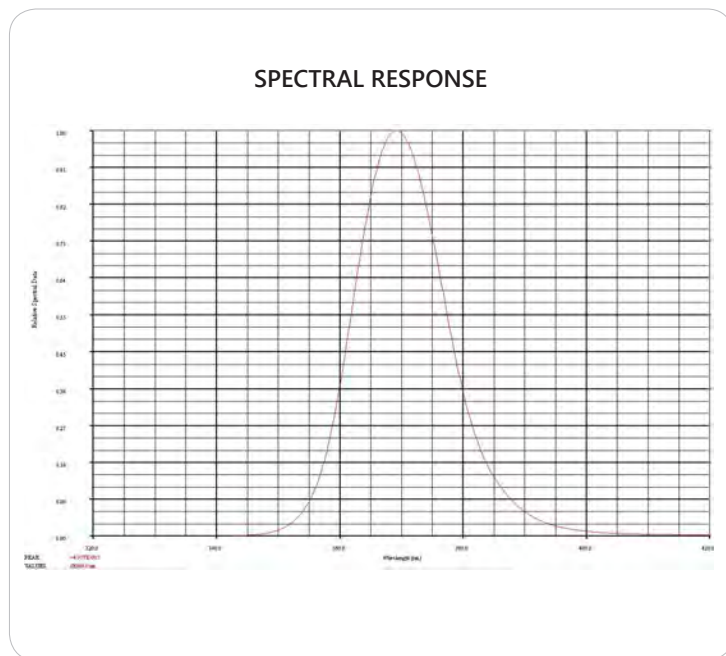
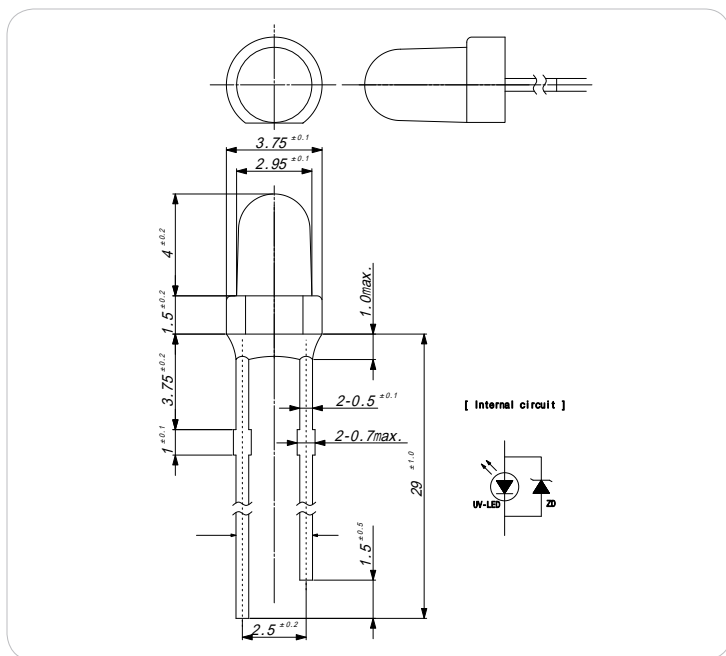

RADIATION DISTRIBUTION

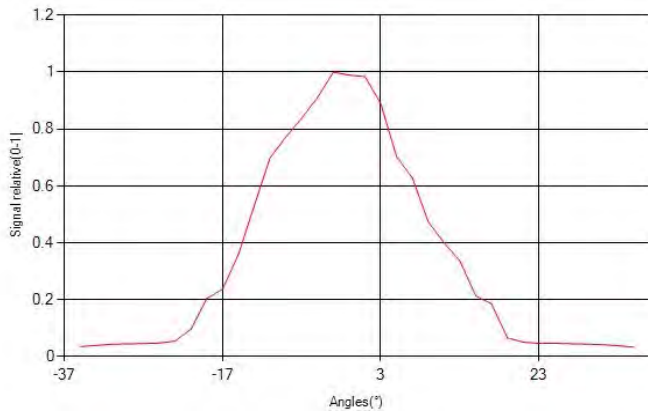

VIEW ANGLE

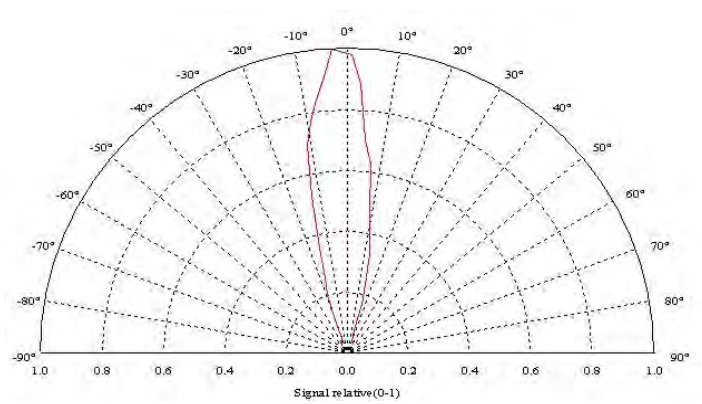

RELATIVE POWER vs FORWARD CURRENT

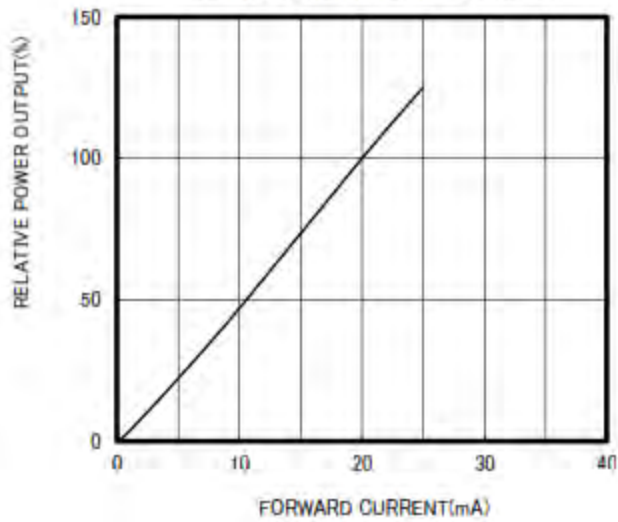



 **CAUTION**

1. LEDs emit very strong UV radiation during operation.
2. Don't look directly into the LED light when in operation as UV radiation can harm your eyes.
3. To prevent even inadequate exposure, wear protective eyewear.
4. If LEDs are embedded in devices, please indicate warning labels against the UV LED used.
5. Avoid prolonged exposure to skin or other tissue during operation.
6. Keep out of reach of children.
7. Take appropriate precautions around pets and other living organisms to avoid UV exposure.
8. Specification and dimension are subject to change without notice.